

PRZEKRÓJ H-H
SKALA 1 : 7

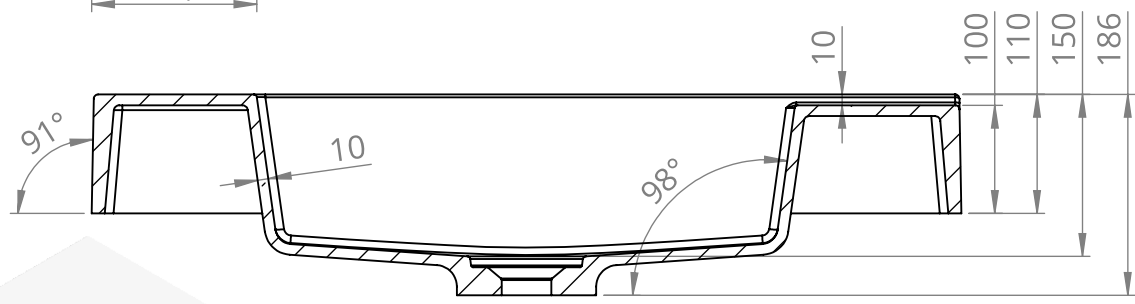

PRZEKRÓJ G-G
SKALA 1 : 7

